

Network

We, SAMSON Co., Ltd., have been engaged in the manufacture and sales of various Boilers and Food Processing Equipment since our foundation in 1945, and have been enjoying a good reputation from customers in various industrial fields of Japan.

In overseas markets, we have devoted ourselves to exporting our products into mainly Asian countries for a long period and have delivered them to many customers.

After delivery, our authorized distributors in the respective countries have taken care of maintenance services on our equipment through the cooperation from customers.

We are supporting our distributors for the improvement of maintenance technology and we hope our customer can operate our products safely without any trouble.

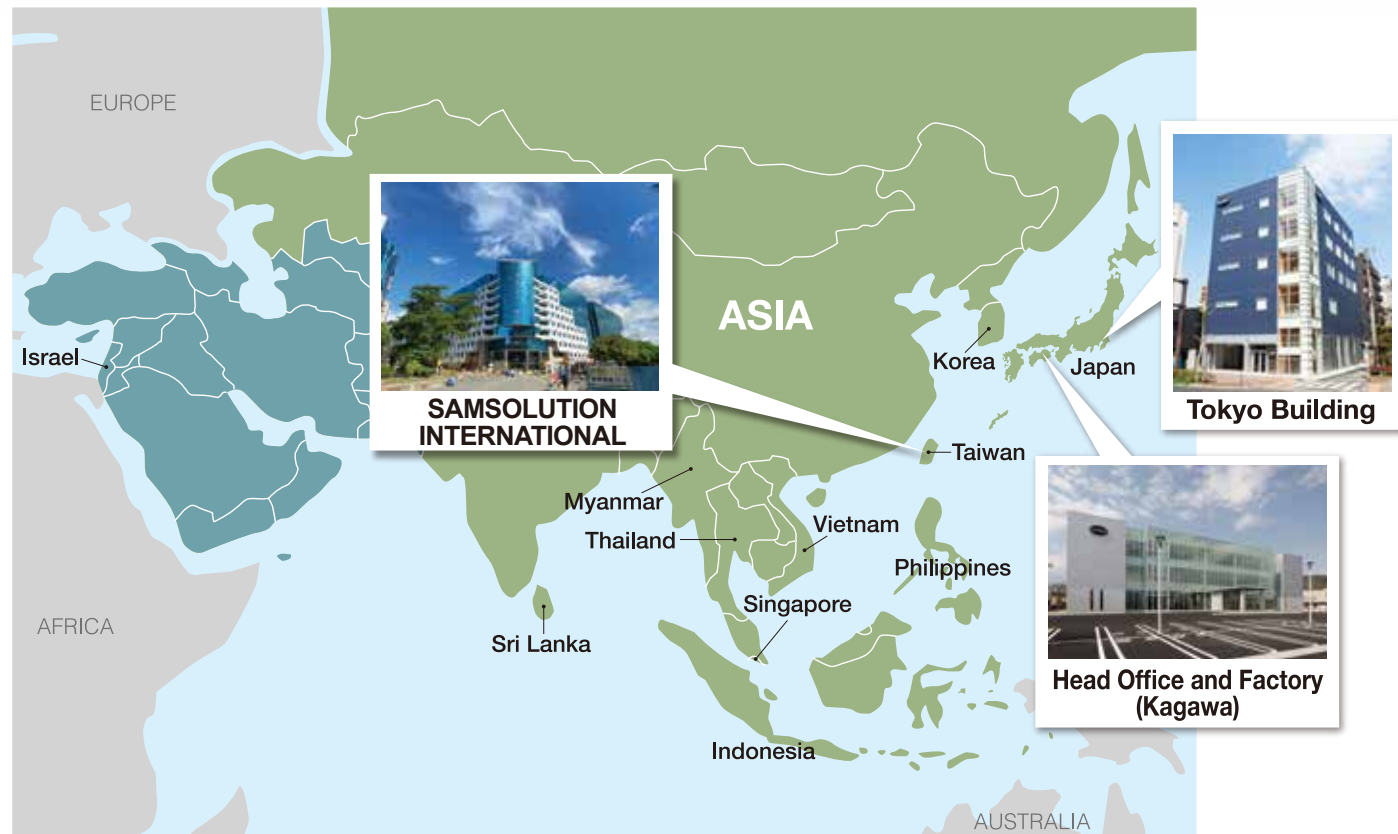

SAMSON CO.,LTD.

Tokyo Building(International Division)

ADDRESS	1-4-1 Omori-honcho, Ota-ku, Tokyo 143-0011 Japan
T E L	+81-3-6423-1171
F A X	+81-3-3761-0342
E - M A I L	overseas@samson.co.jp
WEB SITE	https://www.samson.co.jp/en/

SAMSOLUTION INTERNATIONAL CO., LTD.

ADDRESS	7F-8, NO.12, LN.609, SEC.5,CHONGXIN RD., SANCHONG DIST., NEW TAIPEI CITY 24159, TAIWAN(R.O.C.)
T E L	+886-2-2278-3636
F A X	+886-2-2278-3535
WEB SITE	https://www.samson.co.jp/tw/

SAMSOLUTION

For a sustainable future of energy and food

SAMSOLUTION FOOD SYSTEM

SGC·CB series

Made in **Japan**
since 1945



Cooking sterilizer SGC·CB Type



1 Heating evenly by showering hot water from the top, left, and right

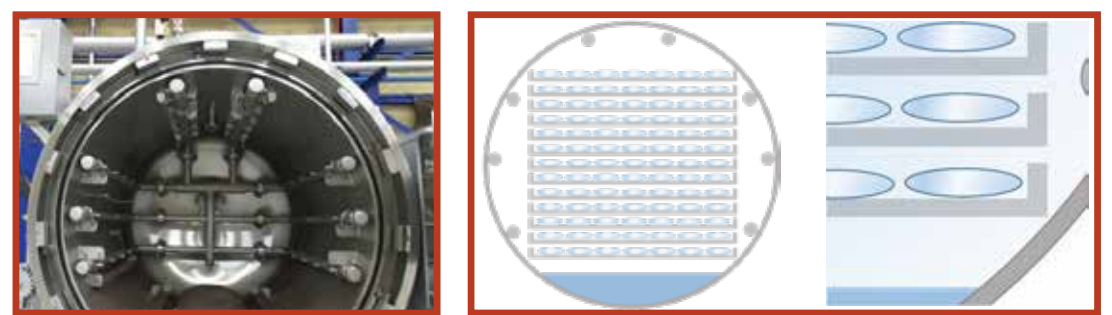

This ideal heating structure makes the product to be safely sterilized.

- The large nozzle tip prevents nozzle clogging
- Automatic detection of nozzle clogging
- Suitable flow rate (water pump pressure) monitoring

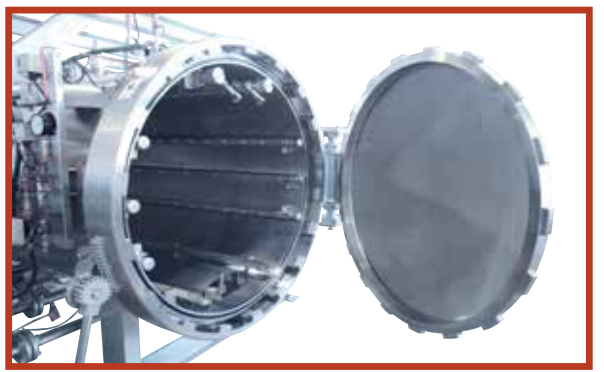

2 Accurate temperature control from low (60°C) to high (130°C)

130°C	High Temp. cooking sterilization 110~130°C	Curry	Simmered mackerel in miso	Oden
110°C	High Temp. vacuum cooking 95~110°C	Hamburg steak	Braised meat and potatoes	Simmered pumpkin
95°C	Low Temp. vacuum cooking 60~95°C	Roast beef	Potato salad	Jelly
60°C				

3 Multi-step heating and temperature control program

- Multi-step heating : Slow heating reduces damage to the food and makes the product completely sterilized at the same time.
- Temp. control program : Sterilization under the same conditions every time by setting the same heat-up time.

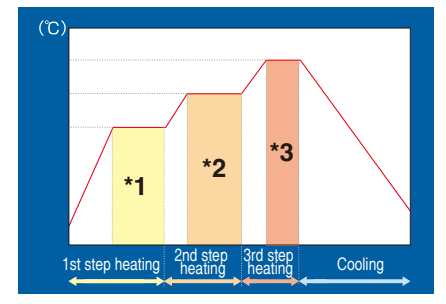

*1 Pre-heating
*2 Cooking
*3 Sterilization

4 HACCP : F-value monitor required for evaluation of sterilization

- Built-in F-value monitoring function : F-value would be displayed on the operation panel and would be recorded in memory card automatically.

*F-value is a sterilizing value which is time in minutes required to kill an organism.
F=1 equivalent to holding the product 121°C for 1 minute.
Retort food is stated to achieve F=4 or more at Food Sanitation Act in Japan.

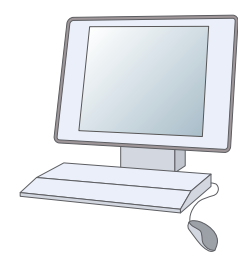
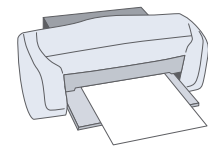

	Temp.	F value
P1	119.9 °C	4.1
P2	119.9 °C	4.1
P3	120.0 °C	4.2
P4	120.0 °C	4.2

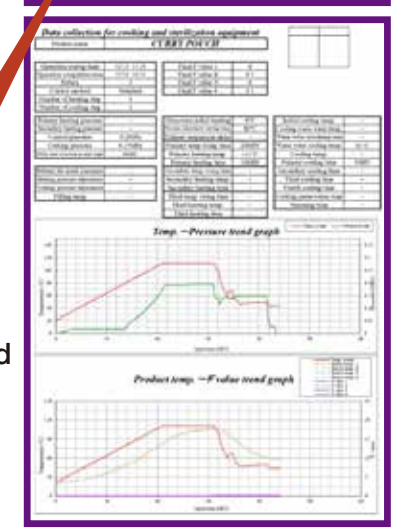

- Record and save the operation data into a memory card automatically : Record and save the operation condition and operation result (time, Temp. inside the tank, pressure, product Temp., F-value) into a memory card. SAMSON original software allows you to create the daily report at your personal computer which is important record for HACCP.

5 Compact design SGC

- SGC's water tank is placed on top of the machine. So there is no need to install a water tank by itself.

6 Reduction of the running cost

- SAMSON shower type sterilizer uses only a small amount of steam which could save energy more than other water tank type sterilizer. In addition, water saving model reuses the hot water used for sterilization as a cooling water by using the cooling tower. So that water usage amount could be reduced.

Model	Electricity	Water	Steam	Total running cost	
SGC 120/20D-SH Standard model	9.6 kWh	1,990 L	146 kg	2,336 JPY / times	per pouch 1.22 JPY
SGC 120/20C-SH Water saving model	10.0 kWh	380 L	146 kg	1,538 JPY / times	per pouch 0.8 JPY

*This value indicates 200g pouch x 1,920 pcs, sterilized 120°C x 20 min.
*The unit price is calculated based on electricity of 18 JPY / kWh, city water of 500 JPY / m3, and steam of 8 JPY/kg. (City Water charges include tap water and wastewater treatment costs)

7 Prevent air-containing container from transforming by suitable control

- When you cook and sterilize the air-containing containers, accurate pressure control is required to prevent containers from bursting. The pressure control used to be based on a theoretical value calculated from product Temp..(Traditional control system) However it may not be as theoretical value depending on moistness of the food, evaporation speed, state change or air amount inside the container.
- Accurate pressure control could be performed by inputting a suitable pressure data of the product. (Samson control system)

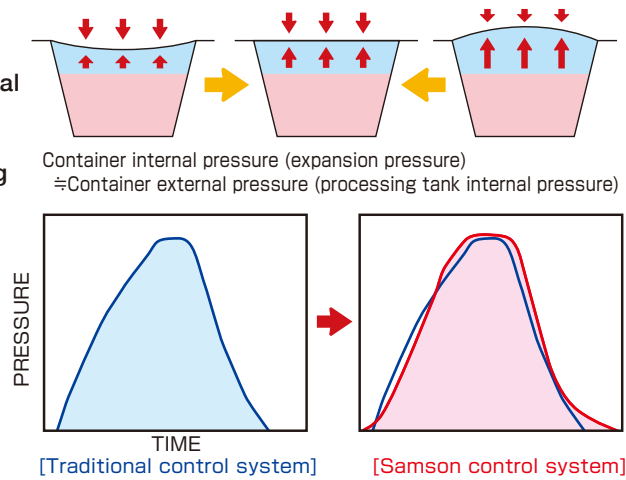

8 Operation settings could be registered for each 50 kinds of products with security function

Registration table screen

No	Product name	Control	Heating	Cooling
1	FISH THE BONES OF WHICH ARE EATABLE	Standard	2 steps	2 steps
2	PUFFY COOKED BEANS	Standard	2 steps	2 steps
3	HOTCHPOTCH WITH LIGHT DRY TEXTURE	Aired container	2 steps	1 step
4	KAKUNI	Standard	2 steps	3 steps
5	HOT RICE PORRIDGE	Standard	2 steps	2 steps
6	BEEF CURRY	Standard	1 step	2 steps
7	STRAWBERRY JAM	Standard	2 steps	2 steps
8	A CUP OF "ZENAI"	Aired container	1 step	1 step
9	BAMBOO-SHOOT RICE	Aired container	2 steps	1 step
10	STEAMER STERILIZATION	Steam	1 step	1 step

Password setup screen

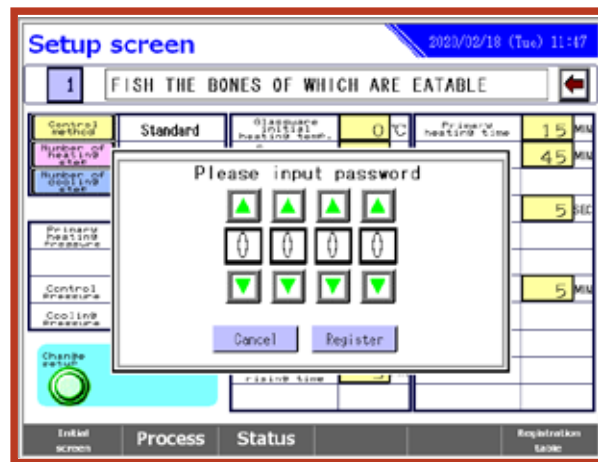

Setup screen (1)

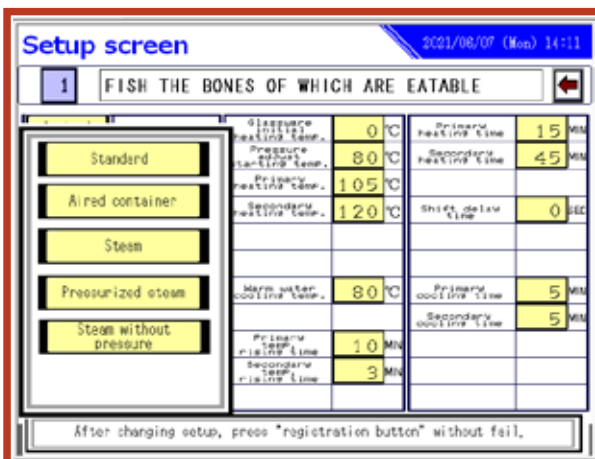

Setup screen (2)

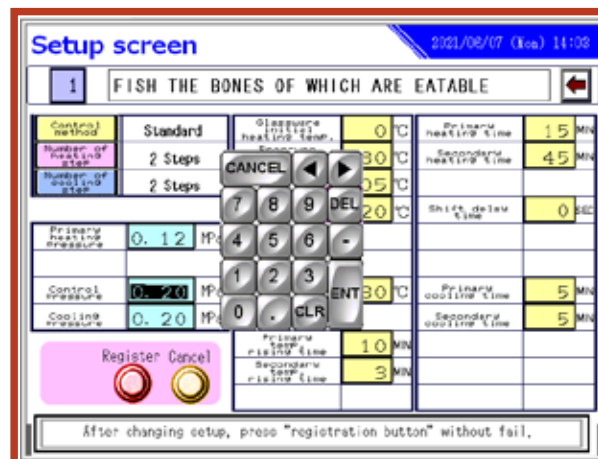

The touch panel makes it easy to set operation conditions.

9 Easy operation

Start screen



Start operation with one button. No complicated operation which is user-friendly.

Process display screen

Temp. in tank	Pressure in tank	Temp. F value	P1	P2	P3	P4
120.1 °C	0.196 MPa		119.9 °C 4.1	119.9 °C 4.1	120.0 °C 4.2	120.0 °C 4.2

Error confirmation screen

10 Various control functions

- Stable pressure sterilization control for pouched



Curry or soup

- Jar sterilization control



Jam

- Control for air-containing containers



Rice

Soup

- Control for steaming

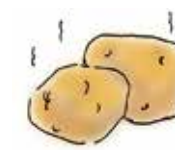

Potato

- Steam sterilization control for canned foods



Canned fish

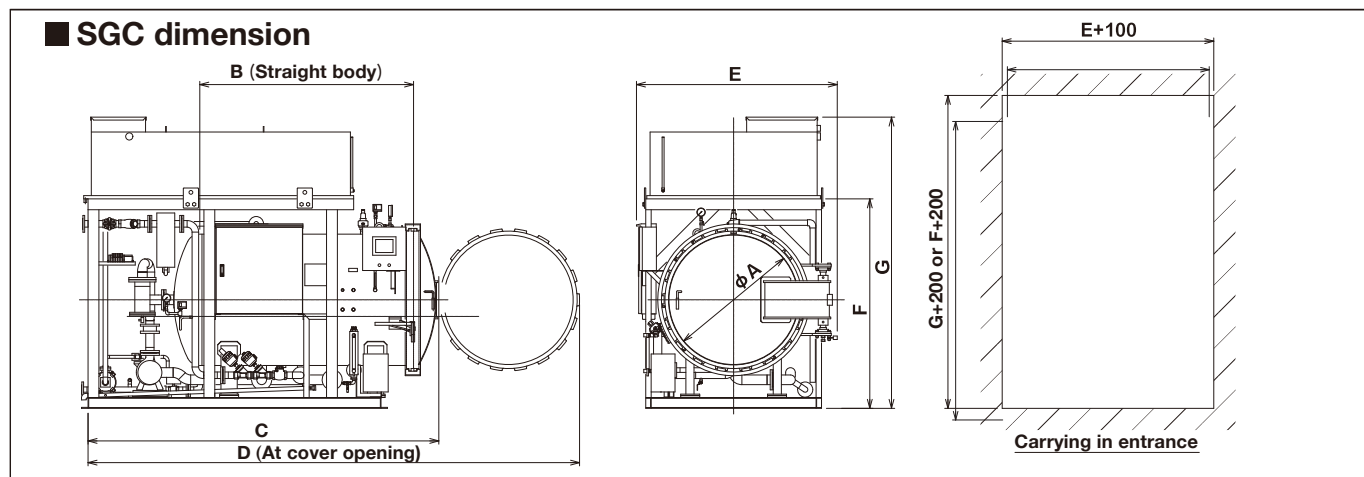

● D-SH type (Standard model)

Model	A	B	C	D	E	F	G	Dry weight (kg)	Weight in operation (kg)
60/10D-SH	600	810	1,865	2,580	1,475	1,400	1,900	990	1,750
80/10D-SH	800	1,010	2,165	3,090	1,675	1,500	2,040	1,300	2,720
80/20D-SH		1,970	3,090	4,005	1,570	1,500	2,070	1,700	3,480
100/10D-SH	1,000	1,010	2,190	3,295	1,700	1,700	2,320	1,640	3,390
100/20D-SH		1,970	3,330	4,435	1,720	1,700	2,320	2,300	4,900
120/10D-SH	1,200	1,010	2,185	3,495	1,830	1,880	2,600	2,050	3,900
120/20D-SH		1,970	3,325	4,630	1,850	1,930	2,685	2,700	6,320
120/30D-SH		2,930	4,465	5,770	1,870	1,880	2,685	3,500	8,830
120/40D-SH		3,890	5,425	6,730	1,880	1,930	2,785	4,150	11,230

● C-SH type (Water saving model)

Model	A	B	C	D	E	F	G	Dry weight (kg)	Weight in operation (kg)
80/20C-SH	800	1,970	3,420	4,335	1,570	1,500	2,070	1,760	2,870
100/10C-SH	1,000	1,010	2,515	3,610	1,720	1,700	2,270	1,820	2,510
100/20C-SH		1,970	3,490	4,595	1,720	1,700	2,320	2,330	3,710
120/10C-SH	1,200	1,010	2,540	3,835	1,865	1,930	2,500	2,070	3,280
120/20C-SH		1,970	3,565	4,870	1,865	1,930	2,550	2,800	4,650
120/30C-SH		2,930	4,695	5,920	1,820	1,930	2,600	3,500	6,250
120/40C-SH		3,890	5,720	7,030	1,820	1,930	2,550	3,900	7,560

● D-SH type (Standard model)

Model	Unit	60/10D-SH	80/10D-SH	80/20D-SH	100/10D-SH	100/20D-SH	120/10D-SH	120/20D-SH	120/30D-SH	120/40D-SH	
Max. operation pressure	MPa	0.50									
Inner capacity	m ³	0.28	0.61	1.09	0.98	1.73	1.46	2.54	3.63	4.71	
Total electric consumption	kW[50/60Hz]	3.2/3.5	5.3	7.1	7.1	8.2	7.1	10.2	15.2	22.7	
Used steam amount	kg/ batch	16	32	61	61	89	73	139	207	274	
Required boiler capacity	kg/h	150	300	500	500	1,000	750	1,500	2,000	2,500	
Compressor	kW	3.7	5.5	2.2	2.2	3.7	3.7	3.7	5.5	7.5	
Air tank	m ³	—	—	1	1	1	1	1	2	2	
Number of trolley	set	1	1	2	1	2	1	2	3	4	
Usable dimension / Trolley	W×L×Hmm	420×740×340		490×940×490		620×940×640		820×940×800			
Number of tray loaded / Trolley	pcs	13		19		25		32			
Number of processable pouch / Trolley	pcs	156		285		500		960			
Number of processable pouch / Batch	pcs	156	285	570	500	1,000	960	1,920	2,880	3,840	

● C-SH type (Water saving model)

Model	Unit	80/20C-SH	100/10C-SH	100/20C-SH	120/10C-SH	120/20C-SH	120/30C-SH	120/40C-SH	
Max. operation pressure	MPa	0.50							
Inner capacity	m ³	1.09	0.98	1.73	1.46	2.54	3.63	4.71	
Cooling tower	Cooling ton	20	20	40	20	50	80	100	
Total electric consumption	kW[50/60Hz]	9.0	9.0	11.2	9.0	13.9/13.2	21.1	30.1	
Used steam amount	kg/ batch	61	61	89	73	139	207	274	
Required boiler capacity	kg/h	500	500	1,000	750	1,500	2,000	2,500	
Compressor	kW	2.2	2.2	3.7	3.7	3.7	5.5	7.5	
Air tank	m ³	1	1	1	1	1	2	2	
Number of trolley	set	2	1	2	1	2	3	4	
Usable dimension / Trolley	W×L×Hmm	490×940×490		620×940×640		820×940×800			
Number of tray loaded / Trolley	pcs	19		25		32			
Number of processable pouch / Trolley	pcs	285		500		960			
Number of processable pouch / Batch	pcs	570	500	1,000	960	1,920	2,880	3,840	

■ D-SH type (Standard model) flow sheet

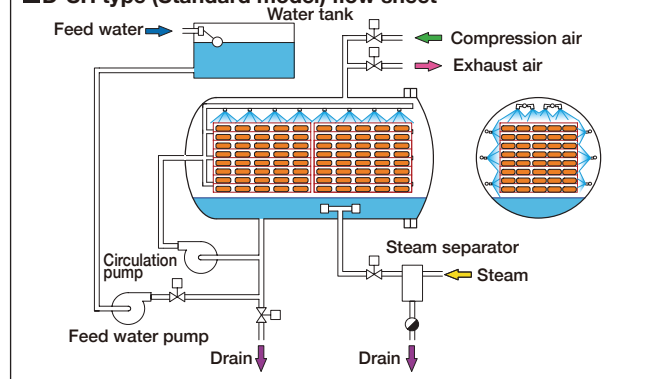

■ C-SH type (Water saving model) flow sheet

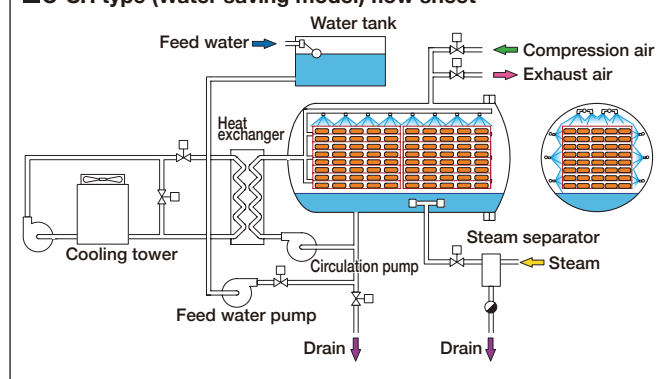

CB dimension

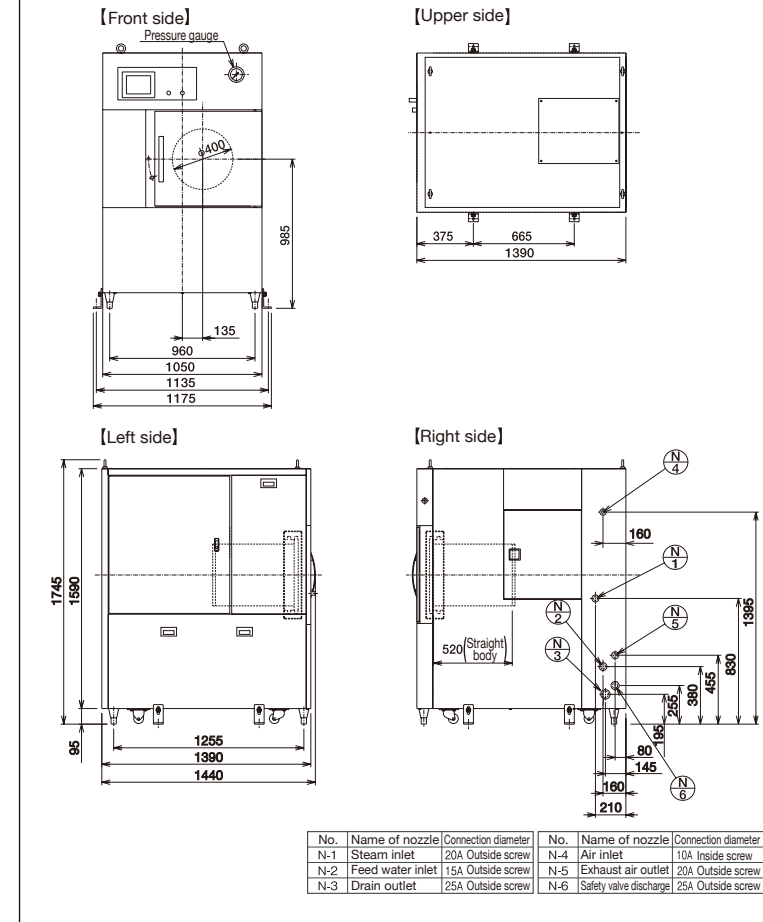

Model		CB-40
Max. sterilization pressure		0.27MPa
Max. sterilization temp.		130°C
Sterilization tank	Max. operation pressure	0.3MPa
	Max. operation temp.	143°C
	Dimensions	Φ400×520mm
	Inner capacity	0.066m ³
Available inside dimension (W×D×H)		266×500×240mm
Total electric consumption		1.7kW
Steam amount		8kg/batch
Required ancillary equipment	Boiler capacity	60kg/h
	Compressor	0.75kW
Number of processable pouch / batch		54pouch / batch*

*Calculated with pouch size : 130 × 170 × H20mm

Taste Room

Location of Taste Room :
Head Office(kagawa) and Tokyo Building



Eager to make more delicious dishes and meals !

It is uneasy to buy new production equipment...

Can not satisfied with existing manufacturing process !

Do you have such problem?

We want to develop a new product!

Please use Samson Taste Room.

The Samson Taste Room is a room(place) to cook the dishes in accordance with the needs(requirement) of customers by using various test machines for food production and processing. Customer can check and taste the dishes after cooking. Our experienced professional staff will assist you in making your original products by using our various recipes.

Try SAMSON'S

- Kneader
- Steam Cooker
- Kneader Vacuum Cooker Pressurized Cooker
- Vacuum Cooler
- Cooking Sterilizer

*Follow the position in photo

We regularly hold various seminars on "food".

